

WEATHER MONITOR II<sup>®</sup>



OWNER'S MANUAL

Product Numbers: 7440 {CS, EZ, W, WS, M, EU, UK}

Davis Instruments Part Number: 7395.002

Weather Monitor II®

Controlled Online: DI:Weather Manuals:Consoles:Weather Monitor II  
Rev. F Manual (5/4/00)

This product complies with the essential protection requirements of the  
EC EMC Directive 89/336/EC.

© Davis Instruments Corp. 2000. All rights reserved.

Weather Monitor II and WeatherLink are registered trademarks of Davis  
Instruments Corp.

Macintosh is a registered trademark of Apple Computer, Inc. Windows is  
a trademark of Microsoft Corp. Duco is a registered trademark of Dev-  
con. All other brand or product names are trademarks or registered  
trademarks of their respective companies or organizations.

---

# TABLE OF CONTENTS

<b>INTRODUCTION</b> . . . . .	<b>1</b>
System Components . . . . .	1
Optional Accessories . . . . .	2
Tools and Materials Needed for Installation . . . . .	3
A Typical Installation . . . . .	4
<b>ASSEMBLING THE STATION</b> . . . . .	<b>5</b>
Powering the Weather Monitor II . . . . .	5
Connecting the Console and Junction Box . . . . .	6
Assembling the Anemometer . . . . .	6
<b>TESTING THE STATION.</b> . . . . .	<b>9</b>
Testing the Anemometer . . . . .	9
Testing the External Temperature Sensor . . . . .	9
<b>INSTALLING THE STATION</b> . . . . .	<b>10</b>
Installing the Anemometer . . . . .	10
Installing the External Temperature Sensor . . . . .	12
Mounting the Junction Box . . . . .	13
Displaying the Console . . . . .	14
<b>USING THE WEATHER FUNCTIONS</b> . . . . .	<b>16</b>
Using the Enter Key . . . . .	16
Highs and Lows . . . . .	17
Time and Date . . . . .	18
Temperature . . . . .	19
Wind Speed and Wind Direction . . . . .	21
Wind Chill . . . . .	23
Rainfall . . . . .	24
Barometric Pressure . . . . .	24
Humidity . . . . .	27
Dew Point . . . . .	29
<b>USING THE CONSOLE FUNCTIONS</b> . . . . .	<b>30</b>
Alarms . . . . .	30
Total Clear . . . . .	33
Auto Scan . . . . .	34
Display Lamp . . . . .	35

<b>CALIBRATION NUMBERS</b> . . . . .	<b>36</b>
Inside and Outside Temperature . . . . .	36
Wind Speed . . . . .	36
Humidity. . . . .	36
Rainfall . . . . .	37
Changing Calibration Numbers . . . . .	37
Resetting Calibration Numbers to Default. . . . .	38
<b>TROUBLESHOOTING GUIDE</b> . . . . .	<b>39</b>
Console Tips . . . . .	39
Temperature Tips . . . . .	40
Humidity Tips. . . . .	41
Wind Tips. . . . .	41
Wind Chill Tips. . . . .	41
<b>WARRANTY AND REPAIRS</b> . . . . .	<b>42</b>
One Year Limited Warranty. . . . .	42
Questions? Call the Davis Service Center. . . . .	42
FCC Part 15 Class B Registration Warning . . . . .	42
Specifications . . . . .	43

# 1. INTRODUCTION

The Weather Monitor II provides sophisticated monitoring and logging of essential weather conditions such as inside and outside temperature, barometric pressure, wind direction, wind speed and wind chill. This instruction manual takes you step-by-step through the process of assembling, testing, and installing your Weather Monitor II so you can begin collecting data as soon as possible.

The standard station comes with all the sensors necessary to monitor the essential weather conditions described above. For instructions on how to install and operate optional accessories, such as the Rain Collector or the External Temperature/Humidity Sensor, please refer to the appropriate manual.

If you have a non-standard station (e.g. Wireless or EZ-Mount), please refer to the separate installation manual provided before continuing with this installation.

## SYSTEM COMPONENTS

Your Weather Monitor II consists of the following components. Please check to be sure you have all of the components listed before proceeding.

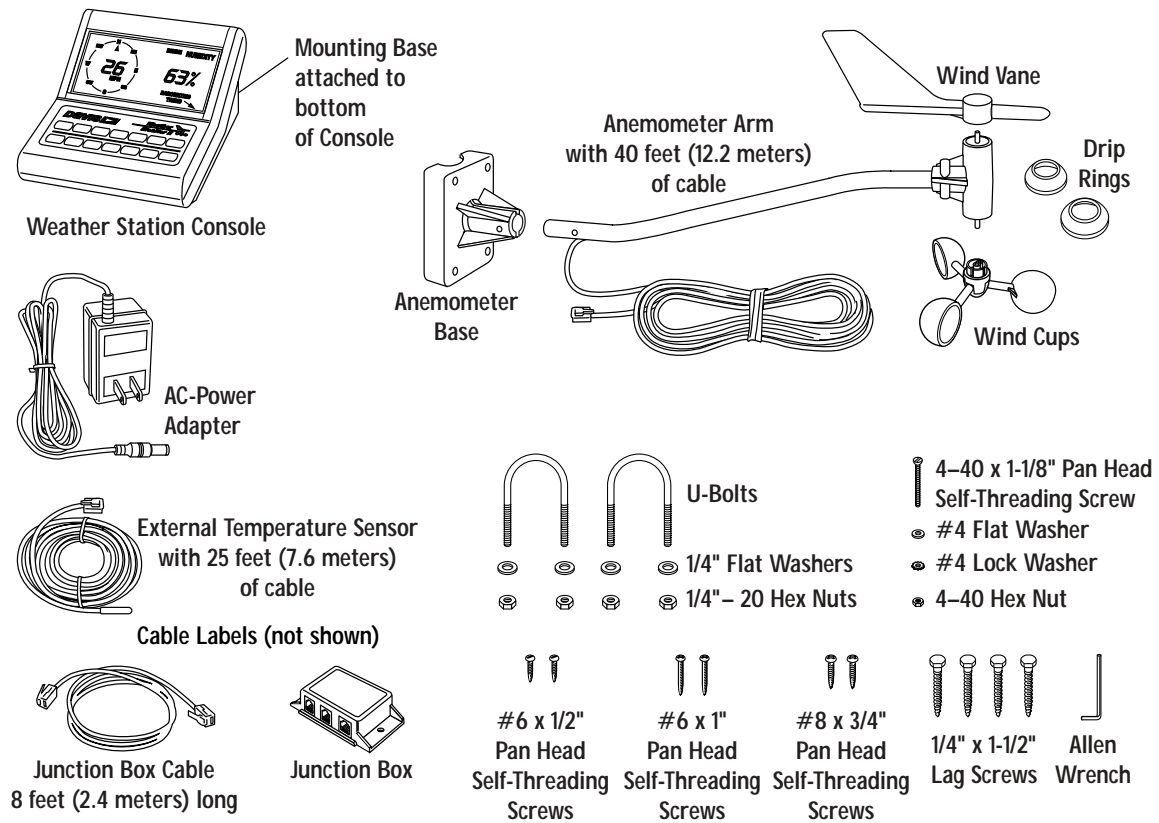

## OPTIONAL ACCESSORIES

The following accessories are designed for use with the Weather Monitor II.

- **External Temperature/Humidity Sensor**  
Replaces the standard external temperature sensor. Allows you to measure outside humidity and dew point in addition to temperature. Includes 40 feet (12.2 meters) of cable.
- **Rain Collector**  
Enables you to measure daily and accumulated rainfall. Separate models measure rainfall in either 0.01 inch or 0.2 mm increments. Optional Rain Collector Heater allows you to measure freezing rain or the moisture content of snowfall.
- **WeatherLink<sup>®</sup> Software and Data Logger**  
Logs data gathered by the Weather Monitor II, downloads it to your PC or Macintosh<sup>®</sup>, and generates reports and graphical displays of your weather data.
- **Car/Boat/RV Lighter Cord**  
Uses the cigarette lighter in your car, RV, truck, or boat to power the Weather Monitor II. Replaces the standard AC-power adapter.
- **Sensor Mounting Arm**  
A single-location mounting option for all your sensors. Includes positioning for anemometer, external temperature or temperature/humidity sensor (with Radiation Shield), and Rain Collector (with Rain Collector Shelf).
- **Radiation Shield**  
Protects the temperature or temperature/humidity sensor from the sun and the effects of radiated and reflected heat. Increases the life of the sensor and the accuracy of the readings.
- **Protected Junction Box**  
Provides upgraded protection against radio frequency interference (RFI), electrostatic discharges (ESD), and power surges that can come through sensor wires. Replaces junction box included with the station.
- **Extension Cables**  
Extends cable length for total cable runs of 80-140 feet (24-42 m) sensor to console. Order the 4-Conductor Extension Cable [in lengths of 40 feet (12 m) or 100 feet (30 m)] for use with the anemometer, external temperature sensor, Rain Collector, or WeatherLink. Order the 6-Conductor Extension Cable [in lengths of 40 feet (12 m) only] for use with the External Temperature/Humidity Sensor.
- **Junction Box Cables**  
Order a Standard 8-Conductor Cable for greater flexibility in the placement of your console. Comes in lengths of 25, 50, and 100 feet (7.6, 15.2, and 30.4 m).

## TOOLS AND MATERIALS NEEDED FOR INSTALLATION

In addition to the enclosed components, you will need the following tools and materials to complete the installation. Please be sure you have everything you need before proceeding with the installation.

- Cable clips or weather resistant cable ties—with screw holes or other means for mounting
- Small and medium-sized screwdrivers
- Hand-held magnetic compass or local area map
- Hammer
- Small adjustable wrench
- Duco<sup>®</sup> Cement (or similar adhesive or glue for gluing plastic). Note that we do not recommend the use of “super glue” type products.

### Optional Tools and Materials

- 9-volt alkaline battery to be used as backup power supply (page 6)
- Carpenter’s level to level the anemometer base (page 10)
- Electric drill with 3/16” (4.8 mm) and/or #29 (0.136” or 3.5 mm) drill bits to drill pilot holes (page 10 and page 13)
- Electric tape if mounting the anemometer on metal mast or pipe (page 11)
- 2 stainless steel hose clamps if mounting the anemometer on pipe with diameter greater than 1 1/4” (32 mm) (page 11)
- Standard switch box if mounting the console with the wires running inside the wall (page 14)
- Medium Phillips screwdriver if mounting the console on a wall (page 15)

## A TYPICAL INSTALLATION

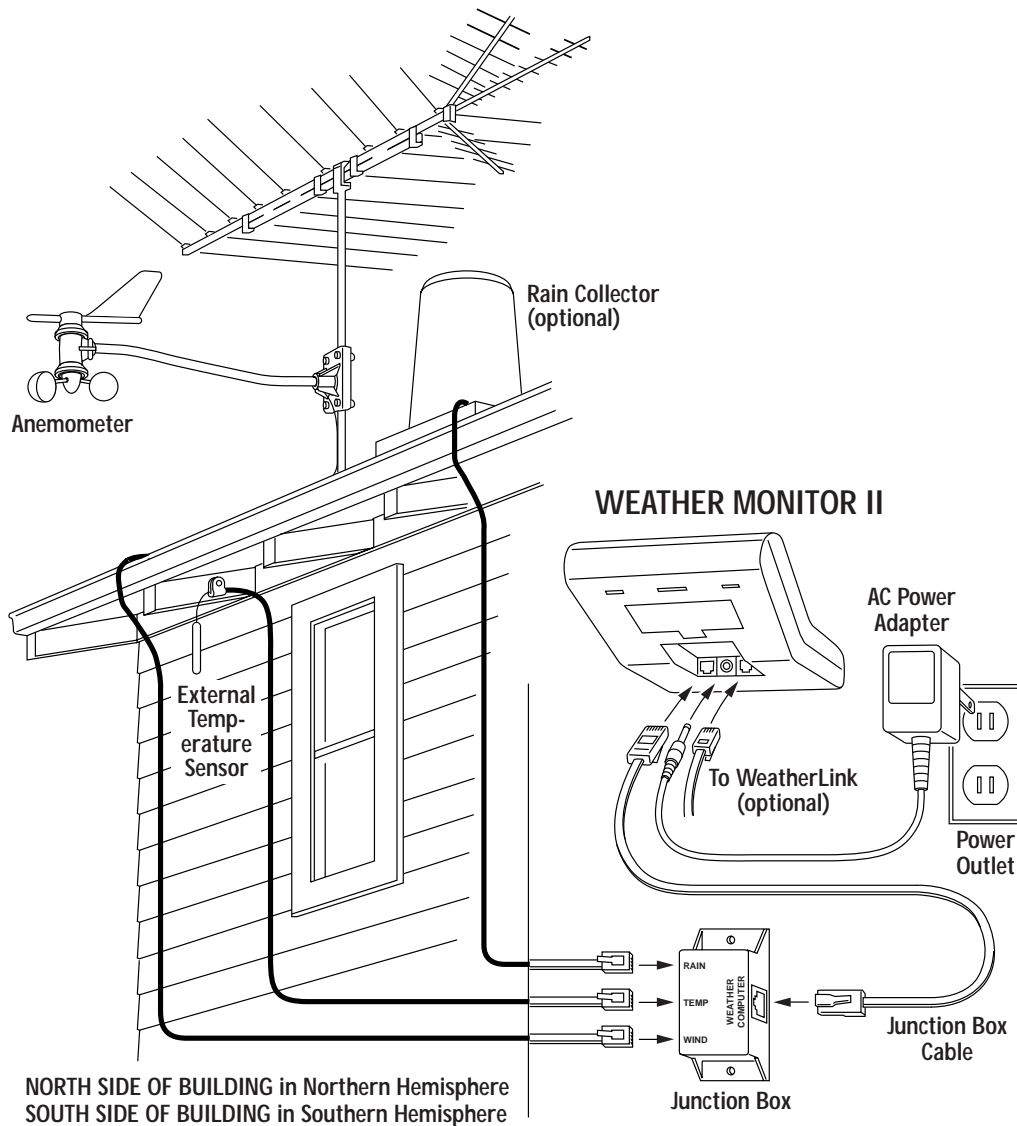

The diagram above shows a typical Weather Monitor II installation. The following pages will give you specific instructions for installing your station. To avoid unnecessary problems, be sure to thoroughly test your system before installing it.

**WARNING:** Climbing on your roof can be hazardous. If you are uneasy about installing your unit, please have a qualified professional complete the installation. Davis specifically disclaims any liability for injury or loss resulting from the installation or use of the Weather Monitor II.

---

## 2. ASSEMBLING THE STATION

The Weather Monitor II is a precision instrument, designed to give extremely accurate readings. As with any precision instrument, care must be used during assembly. These instructions detail how to assemble the stations with a minimum of time and effort.

### POWERING THE WEATHER MONITOR II

The Weather Monitor II is powered by 9- to 12-volt DC (direct current). In North America, the power adapter included with your unit converts 120-volt, 60-Hz AC (alternating current) to 9-volt DC, allowing you to run the unit on ordinary household current. You may also run the Weather Monitor II on the 12-volt DC power supplied by a car, boat, or RV battery by using the optional Car/Boat/RV Lighter Cord.

If you are outside North America and in a location where the power supply is not equivalent to the North American standard (120-volt, 60-Hz), check to see if your local dealer has supplied a power adapter that is appropriate for your power supply before you connect the power adapter to the console. If not, you must use a power converter/transformer or the appropriate power adapter (9-volt, 2.5-mm female plug).

In any case, we recommend that you also install a 9-volt alkaline battery as a backup power supply. In the event of a power outage, the battery will power the station. Not only will this prevent the loss of stored data in the console, but will also allow you to continue observing weather conditions during the power outage.

New alkaline batteries will power the Weather Monitor II for 24 - 48 hours. For maximum security, keep the battery backup fresh. You should replace batteries any time the unit has operated on battery power for more than 18 hours. To prevent loss of data when replacing batteries, make sure the unit is receiving power from the adapter before changing batteries. **Whenever you repower the unit, press and hold down CLEAR for approximately 12 seconds to clear erroneous highs and lows.**

---

**Note:** *We do not recommend the use of Ni-Cad batteries. Ni-Cad batteries carry less power than alkaline batteries, and they will not be recharged by the station. In the event of a power outage, Ni-Cad batteries will be able to power the station for a shorter period of time than alkaline batteries will.*

---

#### To Connect the Power Adapter to the Console

1. Remove the mounting base from the console.  
Push down on the large tab behind the display until it will easily slide out from the notch. Then lift the mounting base so the two smaller tabs behind the keyboard slide free. Place the mounting base aside until you mount the console (see "Displaying the Console" on page 14).
2. Slide the power adapter plug into the jack marked POWER underneath the console.

3. Plug the other end of the power adapter into an appropriate power outlet or, preferably, into a computer-grade surge protector.

*It is highly recommended that you plug the power adapter into a computer-grade surge protector, especially in high-lightning areas.* Once power is applied, the console should run through a brief self-test procedure. All of the display segments appear, and the console beeps twice within 10 seconds (3 times within 20 seconds if WeatherLink is installed) to indicate everything is working properly.

4. After the second beep (or the third beep with WeatherLink), the compass rose, the barometric trend arrow and the time (reading 12:00 a.m.) appear on the display.

### To Install the Battery Backup Power Supply

Before you install the backup battery, make sure AC power is connected and the console is completely powered up. Installing the battery first can cause the console to lock up.

Once the console is powered up, install the backup battery as shown below.

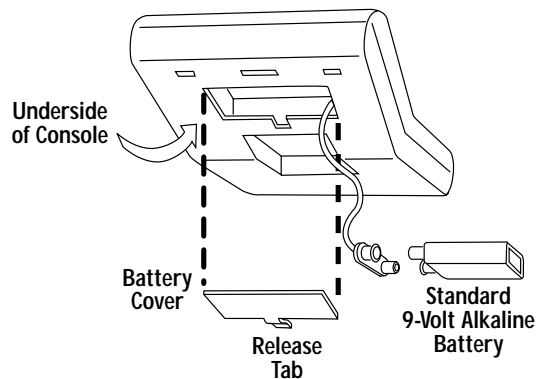

---

**Note:** When the unit is operating on battery power, the digits on the right side of the display blink on and off. The unit operates normally in all other respects.

---

## CONNECTING THE CONSOLE AND JUNCTION BOX

The junction box connects the external sensors and the console. Information from the sensors comes into the junction box. The junction box then relays information to the console where it is processed and displayed.

### To Connect the Console and Junction Box

1. Plug one end of the 8-foot (2.4-meter) long junction box cable into the jack labeled JUNCTION BOX underneath the console.
2. Plug the other end of the cable into the jack marked CONSOLE on the junction box.

## ASSEMBLING THE ANEMOMETER

To assemble the anemometer you need the following: anemometer arm (with cable), anemometer base, wind cups, drip rings, allen wrench, 4-40 x 1 1/8-inch pan head screw, #4 flat washer, #4 lock washer, and 4-40 hex nut.

Avoid lubricating the wind cup shaft and bearings or the wind vane shaft. Natural or synthetic lubricant reduces the anemometer's efficiency.

**Note:** Do NOT attach the wind vane now. Install the anemometer before attaching wind vane. (See page 11)

### To Attach the Anemometer Arm to the Anemometer Base

1. Insert the anemometer arm into the anemometer base, sliding cable through the slot in the base as shown.  
Line up the small hole in the arm with the holes in the base.
2. Insert the 4-40 screw into one of the holes in the base and through the arm.  
The screw should slide easily through the holes.
3. Secure as shown below.

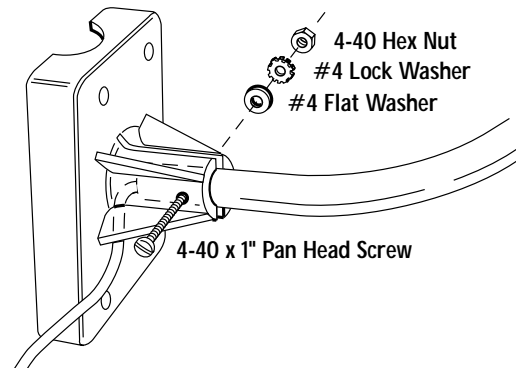

### To Attach the Drip Rings to the Wind Vane and Anemometer Arm

The drip rings protect against icing of the wind vane and wind cups. If you do not install them, the anemometer will function normally in non-icy conditions.

1. Remove the wind cups and wind vane from the anemometer using the allen wrench.  
For details, consult your station or anemometer manual. You may want to make a note of the anemometer's mounted position for later realignment.
2. Place a drip ring on a flat surface with the small hole facing up. Securely press the wind vane on top of the drip ring.

Tilt the vane slightly. Ensure the ring fits securely between the two ridges on the vane

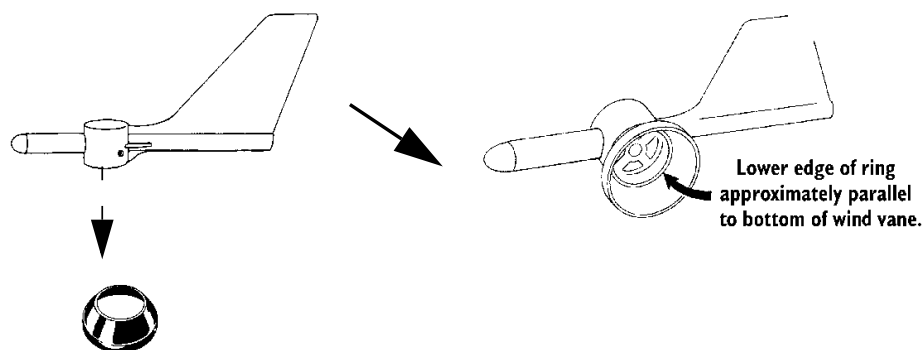

SECURING DRIP RING ON WIND VANE

3. Install the small end of the other drip ring on the **WIND CUP END OF THE ANEMOMETER CONTROL HEAD** as shown below. Gently push up the drip ring until it reaches the groove on the control head.

The wind cup end of the control head has the smaller of the two stainless steel shafts. When attaching the drip ring, make sure the lower edge of the ring is aligned with the lower edge of the control head.

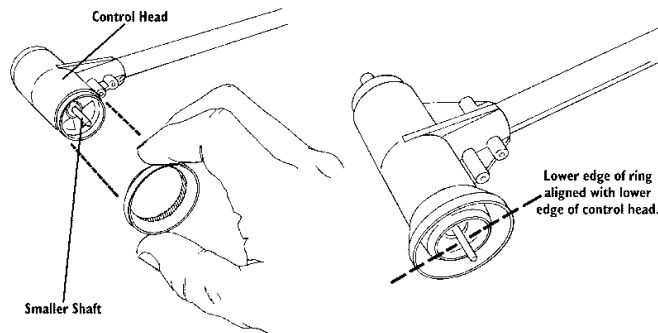

*SECURING DRIP RING ON CONTROL HEAD*

4. After installing the drip ring, reattach the wind vane and wind cups to the anemometer.

For details, consult your station or anemometer manual.

### To Attach the Wind Cups to the Anemometer Arm

1. Push the wind cups onto the smaller of the two stainless steel shafts at the end of the arm.
2. Slide the wind cups as far up the shaft as possible.
3. Use the allen wrench provided to tighten the set screw on the side of the wind cups. Note that when you let go of the wind cups, they should drop slightly.
4. Spin the wind cups. If they do not spin freely, loosen the set screw and lower the cups slightly. Repeat until the wind cups spin freely.

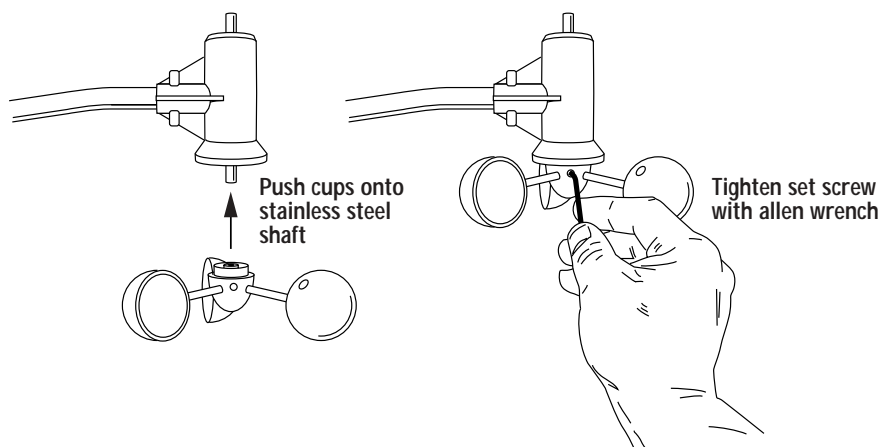

---

## 3. TESTING THE STATION

*Before doing anything else, test the station in your living room or workshop. If you have purchased the optional rain collector or additional sensors, now is the time to assemble and test these using the appropriate manual. Consult the Troubleshooting Guide on page 39, or the guides in the respective manuals, if you experience any difficulty.*

---

**Note:** *You should test each external sensor without extension cables first, and then repeat the test with extension cables. In this way, you can be reasonably sure whether any problems are the fault of the extension cables or the external sensor itself.*

---

### TESTING THE ANEMOMETER

Before you install the anemometer, make sure that the wind speed and wind direction sensors are functioning correctly.

1. **Insert the cable plug at the end of the anemometer cable into the jack marked WIND on the junction box.**
2. **Test your assembly by spinning the wind cups.**  
You should get a speed reading other than 0 on the compass rose in the console display. If you do not, loosen the set screw and move the wind cups slightly up or down on the shaft until you get a reading other than 0. Once you are getting a reading, use the allen wrench provided to tighten the set screw on the side of the wind cups. Do not over-tighten.
3. **Turn the wind direction shaft (the larger of the two stainless steel shafts on the control head) with your fingers.**  
Check that the direction readings change on the compass rose in the console display.

### TESTING THE EXTERNAL TEMPERATURE SENSOR

Be sure you get a reading from the external temperature sensor as well. Or, if you have purchased the optional External Temperature/Humidity Sensor, be sure to test both the temperature and the humidity readings at this time.

#### To Test the Temperature Sensor

1. **Insert the cable plug at the end of the external temperature sensor into the jack marked TEMP on the junction box.**
2. **Press TEMP.**  
A temperature reading and the words INSIDE and TEMPERATURE should appear on the display.
3. **Press TEMP again.**  
A temperature reading and the words OUTSIDE and TEMPERATURE should appear on the display.

## 4. INSTALLING THE STATION

Make sure you have thoroughly tested the station before installing it. Then, decide where you will place each component—the junction box, the console, and all external sensors. Pay close attention to the suggestions given in the sections dealing with the individual components, as well as the following general suggestions:

- The junction box cable must be able to reach the console.  
If you want to place the junction box and console more than 8 feet (2.4 m) apart, you will need a longer junction box cable (see page 2).
- The cable coming from each external sensor must be long enough to reach the junction box.  
If the sensors are placed farther away than their allotted cable lengths allow, use extension cables (see page 2).

### INSTALLING THE ANEMOMETER

Most people install the anemometer on the roofs of their houses, where wind flow is unobstructed by trees and nearby buildings. For the most accurate readings, the anemometer should be mounted at least 4 feet (1.2 m) above the roof line. You can do this by mounting the anemometer on your television antenna or on a raised piece of wood or metal pipe.

We have included the hardware most commonly needed for the installation of the anemometer. The hardware you use depends upon where you install your unit. You may need to adapt or purchase additional hardware to fit your individual requirements. Make sure that you have all of the necessary parts, tools, and materials before you begin.

#### To Install the Anemometer

1. Disconnect the anemometer cable from the junction box.
2. Wrap the WIND cable labels around each end of the cable.
3. Mount the anemometer according to the following instructions. As you do so, use a carpenter's level to make sure the anemometer base is mounted vertically.

#### WOODEN POST OR SURFACE

1. Locate a suitable mounting surface for the anemometer base. The mounting surface should be at least as wide as the anemometer base and level.
2. Hold the anemometer base against the wood surface and use a pencil to mark the location of the four holes on the base.
3. Use an electric drill with a 3/16 inch (4.8-mm) drill bit to make pilot holes in these locations.
4. Drive the four lag screws through the holes in the anemometer base and into the wood.

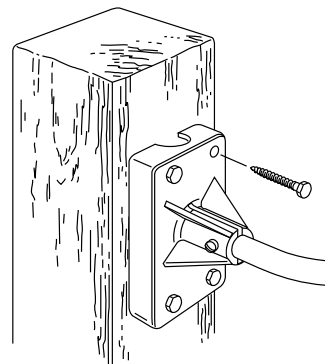

**ANTENNA MAST OR METAL PIPE - OUTSIDE DIAMETER 3/4 TO 1 1/4 INCHES (19 TO 32 MM)**

1. Make sure that the antenna mast or metal pipe is properly grounded. If you are not sure, consult a qualified professional.
2. Hold the anemometer base against the pipe and insert the two U-bolts through the back of the base so that the U-bolts wrap around the pipe.
3. Place a 1/4-inch washer and a 1/4-20 hex nut over each end of the U-bolts. Use a wrench to tighten the hex nuts.

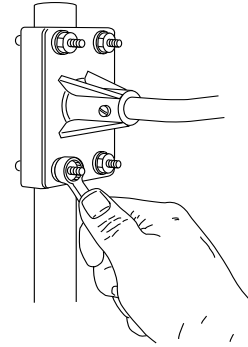
**METAL MAST OR PIPE - OUTSIDE DIAMETER GREATER THAN 1 1/4 INCHES (32 MM)**

1. Obtain two stainless steel hose clamps large enough to fit around the mast or pipe and the anemometer base. These can be purchased at your local hardware store.
2. Make sure that the metal mast or pipe is properly grounded. If you are not sure, consult a qualified professional.
3. Hold the anemometer base against the pipe and fasten the hose clamps over the anemometer base and around the metal mast or pipe.

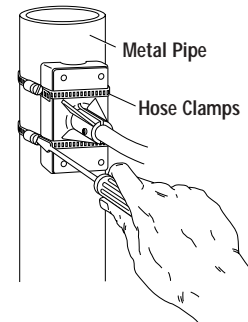
**To Attach the Wind Vane**

To mount the wind vane, you will need to look at the console display. You may wish to have a friend or family member on the ground do this for you. Or, you may wish to bring the console and junction box onto the roof with you.

1. After installing the anemometer, re-insert the plug at the end of the anemometer cable into the jack marked WIND on the junction box
2. Press WIND on the console until a wind direction reading and the word DIRECTION appear on the display.
3. Use a compass or local area map to determine which direction (N, S, E, W, NE, etc.) the anemometer arm is pointing.
4. Use the wind direction chart to find the degree reading which corresponds to that direction.
5. Slowly turn the wind direction shaft with your fingers. Stop turning when the console display reaches the degree reading obtained in step 4.
6. Being careful to keep the stainless steel shaft from turning, place the wind vane on the shaft with the bullet-shaped nose of the vane pointing in the same direction as the arm.

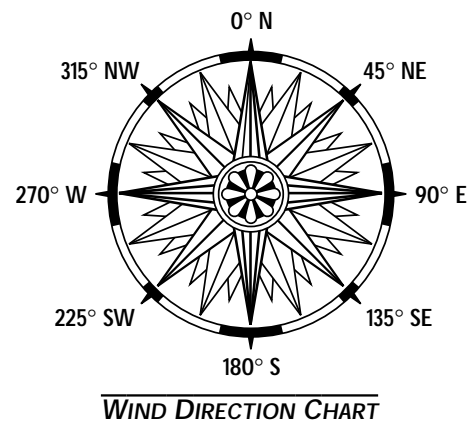

7. Use the allen wrench provided to tighten the set screw on the side of the wind vane. Do not over-tighten.

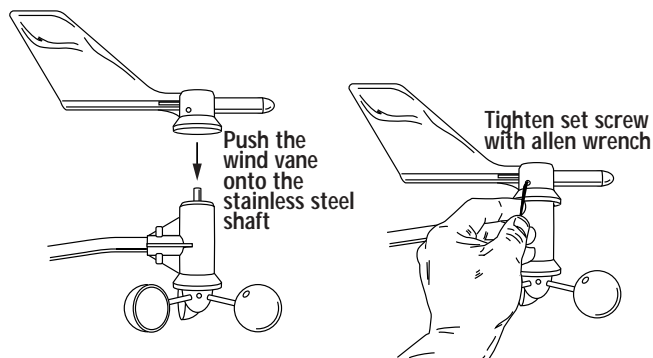

8. Test your assembly by pointing the wind vane in any direction and—using the compass or map as a guide—making sure the console displays the correct wind direction. Re-adjust the wind vane if necessary.

### To Complete the Installation

1. Spin the wind cups to make sure you are getting a wind speed reading. Re-adjust the wind cups if necessary.
2. To prevent fraying or cutting of the anemometer cable, secure the cable so it does not whip about in the wind.

Secure the cable to a metal mast or pipe by wrapping electrical tape around them both. Use cable clips or weather resistant cable ties to secure the cable underneath the eaves of your house or in a location similarly shielded from rain. Make sure the cable is secure by placing clips or ties approximately every 3-5 feet (1-1.6 m).

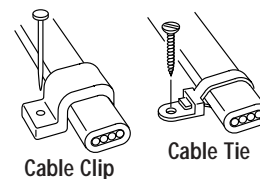

**Note:** Do not use metal staples or a staple gun to secure the cable. Metal staples—especially when installed with a staple gun—have a tendency to cut the cables.

## INSTALLING THE EXTERNAL TEMPERATURE SENSOR

Use the following guidelines when deciding where and how to position the external temperature sensor:

- Place the external temperature sensor in a location shielded from rain. Water may affect the accuracy of the temperature readings.
- Place the sensor in the shade. The black rubber casing on the sensor heats up in direct sunlight. This can cause erroneous temperature readings and/or damage to the sensor.
- Suspend the sensor in the air. Contact with other objects could cause false temperature readings.
- Place the sensor under an eave on your house or building. To shield the sensor from the sun, place it on the north side in the Northern Hemisphere, south side in the Southern Hemisphere.

### To Install the External Temperature Sensor

1. Disconnect the external temperature sensor cable from the junction box.
2. Wrap the TEMP cable labels around each end of the cable.
3. Place the sensor wherever you wish to measure the temperature.
4. Plug the end of the external temperature sensor cable back into the jack marked TEMP on the junction box.
5. Check the temperature display to make sure you are getting a temperature reading.
6. To prevent fraying or cutting of the temperature sensor cable, secure the cable so it does not whip about in the wind.

Secure the cable to a metal mast or pipe by wrapping electrical tape around them both. Use cable clips or weather resistant cable ties to secure the cable underneath the eaves of your house or in a location similarly shielded from rain. Make sure the cable is secure by placing clips or ties approximately every 3-5 feet (1-1.6 m).

---

**Note:** Do not use metal staples or a staple gun to secure the cable. Metal staples—especially when installed with a staple gun—have a tendency to cut the cables.

---

## MOUNTING THE JUNCTION BOX

The junction box may be installed either indoors or outdoors. The junction box is not resistant to moisture, dirt, or other outdoor stresses so, if you plan to install the junction box outdoors, use a weather-proof shelter such as the Davis Multi-Purpose Shelter or Complete System Shelter. If indoors, place the junction box well above the floor so moisture from mopping, impact from vacuum cleaners, or dirt from sweeping will not cause damage to the junction box.

---

**Note:** Before mounting the junction box, make sure that each sensor cable—WIND, RAIN, TEMP or TEMP/HUM—is labelled on either end so as to alleviate confusion both during the installation and whenever you need to disconnect a sensor/component.

---

### To Mount the Junction Box

1. Hold the junction box against the wall (or mounting surface) and use a pencil to mark the location of the holes on the junction box.
2. Use an electric drill with a #36 (2.5-mm) drill bit to make pilot holes.
3. Drive the two #6 x 1/2-inch screws through the holes on the junction box and into the wall (or mounting surface).

## DISPLAYING THE CONSOLE

Most people position the console indoors in a location where the keyboard is readily accessible and the display is easy to read. Some install the console outdoors in a weather-proof shelter (such as the Multi-Purpose or Complete System Shelter).

### Indoors

For the most accurate *indoor* readings, follow these suggestions:

- **Avoid placing the console in direct sunlight.**  
The black casing heats up in direct sunlight. This can cause erroneous readings and/or damage to the unit.
- **Avoid placing the console near radiant heaters, heating/air conditioning ducts, humidifiers, or de-humidifiers.**
- **If you are mounting the console on a wall, choose an inner or interior wall.**  
Avoid walls which heat up or cool down depending on the weather, unless you are specifically targeting that wall's temperature variation.

---

**Note:** *To display the console with the junction box cable running inside the wall, attach the mounting base to an empty switch box, using the two screw holes on the mounting base.*

---

### Outdoors

If you prefer to mount your console *outdoors*, please consider the following:

- **The console is not weather-resistant.**  
If installed outdoors, the console should be mounted inside a weather-proof shelter (e.g., the Multi-Purpose or Complete System Shelter). The console will operate between  $-5^{\circ}$  and  $140^{\circ}$  F ( $-20^{\circ}$  and  $60^{\circ}$  C).
- **The liquid crystal display freezes when the temperature drops below  $32^{\circ}$  F ( $0^{\circ}$  C).**  
Whether or not the display is functioning, the console continues logging data and is able to download the data to a computer for viewing when it's as cold as  $-5^{\circ}$  F ( $-20^{\circ}$  C). The display resumes functioning as the temperature rises. You can use a Multi-Purpose or Complete System Shelter Heater to prevent the display from freezing.
- **The barometer may be less accurate at extreme temperatures [i.e., less than  $50^{\circ}$  F ( $10^{\circ}$  C) or greater than  $90^{\circ}$  F ( $32^{\circ}$  C)].**  
You can use a Multi-Purpose or Complete System Shelter Heater to increase the accuracy of the barometer during the colder months.
- **The console's temperature and humidity sensors may be unreliable in an outdoor shelter.**  
If you mount the console outdoors (in a shelter), it is recommended that you rely on the external temperature or temperature/humidity sensors for the most accurate outdoor readings. The console's temperature readings are necessarily less accurate because of the trapped air within the shelter. The console's humidity sensor is subject to failure in severe climates, even within the shelter.

### To Display the Console on a Tabletop

To display the console on a table or desk, attach the base as shown below and guide the cables through the slots indicated.

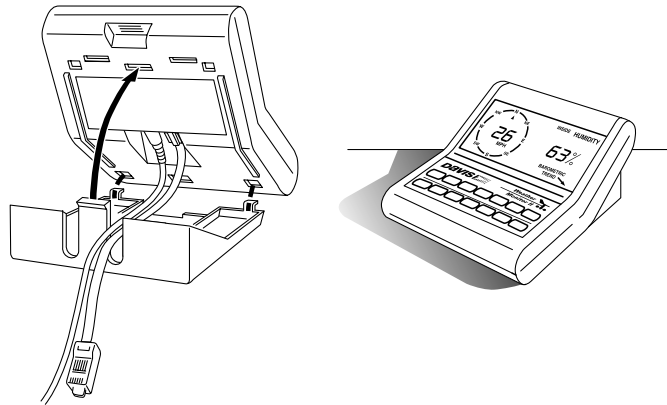

### To Display the Console on a Shelf

To display the console upright on a shelf, attach the base as shown below and guide the cables through the slots indicated.

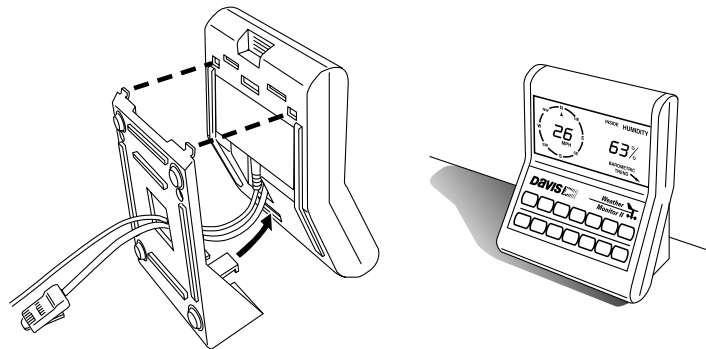

### To Display the Console on a Wall

1. Hold the mounting base flat against the wall and use a pencil to mark the location of the two keyholes.
2. Use an electric drill with a #36 or 2.5-mm drill bit to make pilot holes in these locations.
3. Using a screwdriver, drive the two pan head screws into the wall. Leave at least 1/8 inch (3 mm) between the wall and the heads of the screw.
4. Depending on how high you mount the console on the wall, you can use either tabletop or shelf orientation. Attach the mounting base in the orientation you prefer.
5. Slide the keyholes on the back of the mounting base over the two screw heads. Lock the console into place by gently sliding it downward until it no longer moves.

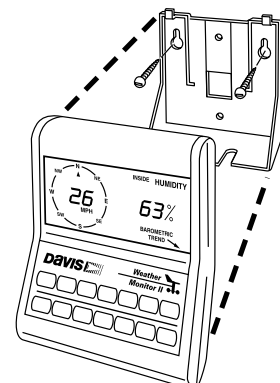

## 5. USING THE WEATHER FUNCTIONS

### USING THE ENTER KEY

The ENTER key is used to enter or change data. You should become familiar with the use of this key, since it serves many purposes in operating the Weather Monitor II.

#### To Change Data Using the Enter Key

1. **Press ENTER and hold it down.**  
The first digit on the left will flash and then begin to cycle through all the possible entries for the function you are changing.
2. **When the display reaches the entry you want, release the ENTER key.**
3. **Press ENTER again and hold it down.**  
The second digit from the left will flash and then begin to cycle through all the possible entries for the function you are changing.
4. **When the display reaches the entry you want, release the ENTER key.**
5. **Repeat this process for the remaining digits.**  
It makes no difference which digit you change first. If you enter a digit incorrectly, accidentally skip past a digit, or only want to change certain digits, simply press and release ENTER until the desired digit is flashing.
6. **Press any key or wait four seconds without pressing ENTER to save the entry.**

---

**Note:** To protect against accidental changing of the barometric pressure once it has been set, the ENTER key must be held down for at least eight seconds before the first digit on the left begins to change for barometric pressure.

---

#### Example of Using the Enter Key - Setting the Time

1. Press TIME until the time setting appears on the display.

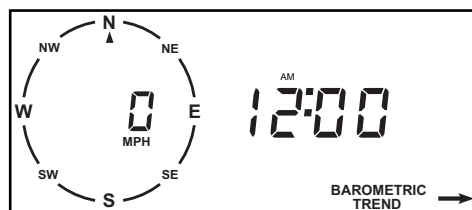

TIME DISPLAY

2. Press UNITS to change from the 12-hour format to the 24-hour format, as desired.  
The 12-hour format is indicated by the symbol AM or PM. The 24-hour format is indicated by the symbol 24HR.
3. **Change the hour by pressing and holding down ENTER.**  
If you are using the 12-hour format, the digits representing the hour (the first two digits on the left) cycle from 12 AM to 11 PM as you hold down ENTER. If you are using the 24-hour format, the digits representing the hour cycle from 0 to 23 as you hold down ENTER.

4. Release ENTER when the current hour appears.
5. Press ENTER again and hold it down to change the tens position in minutes (the third digit from the left).  
The digits cycle from 0 to 5 as you hold down ENTER.
6. Release ENTER when the correct number appears.
7. Press ENTER again and hold it down to change the ones position in minutes (the fourth digit from the left).  
The digits cycle from 0 to 9 as you hold down ENTER.
8. Release ENTER when the correct number appears.
9. Press TIME twice.  
The number you just entered should appear in the display as the current time.

## HIGHS AND LOWS

The Weather Monitor II records highs and lows for many of its functions. Highs and lows are maintained until you manually clear the entries, or until power is interrupted. Depending on how often you clear highs and lows you can track daily, weekly, monthly, yearly, or all-time highs and lows.

	<u>RECORDED HIGH</u>	<u>RECORDED LOW</u>
Inside Temperature	√	√
Outside Temperature	√	√
Wind Speed	√	X
Wind Direction	X	X
Wind Chill	X	√
Barometric Pressure	*	*
Inside Humidity	√	√
Outside Humidity	√	√
Dew Point	√	√

\* See "Barometric Pressure" on page 24 for details on the stored barometric pressure.

In general, highs and lows are displayed by pressing RECL (RECALL) once or twice. The high or low appears in the display along with the word HIGH or LOW and the words which normally accompany the function (e.g., OUTSIDE and TEMPERATURE for outside temperature). Specific instructions for displaying highs and lows may be found within the instructions for each function.

Highs and lows are stored in memory along with the time and the date at which they occurred. To see what time a high or low was recorded, wait a few seconds after pressing RECL. The time the high or low occurred will appear. Wait a few more seconds and the date will appear.

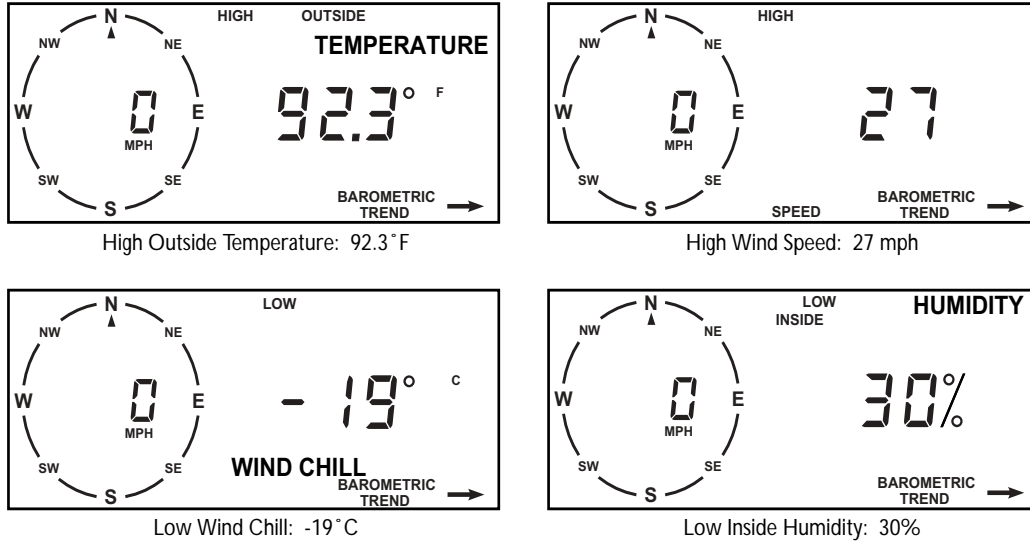

TYPICAL HIGH AND LOW DISPLAYS

## TIME AND DATE

The Weather Monitor II can display time in either a 12-hour or a 24-hour format. In the 12-hour format, either an AM or a PM is displayed with the time. In the 24-hour format, the symbol 24HR is displayed with the time. In either case the hour is on the left, separated from the minutes by a colon.

The date is displayed with the month on the left, separated from the day by three vertical dots. The symbol MO:DAY appears.

### To Display the Current Time and Date

1. To display the time, press TIME.  
The time and symbol AM (or PM or 24 HR) appear on the display.
2. To display the date, press TIME again.  
The date and the symbol MO:DAY appear on the display.

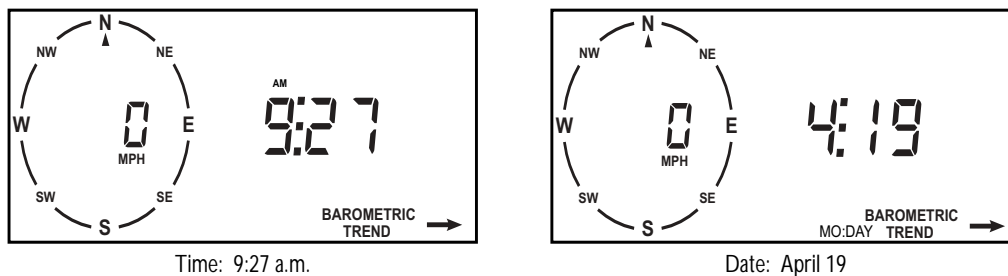

TYPICAL TIME AND DATE DISPLAYS

## To Change the Time Format

1. Press TIME once or twice to select the time.
2. Press UNITS.

The console switches from the 12-hour to the 24-hour format (or vice versa) and the symbol changes from AM or PM to 24 HR (or vice versa). To return to the original format, press UNITS again.

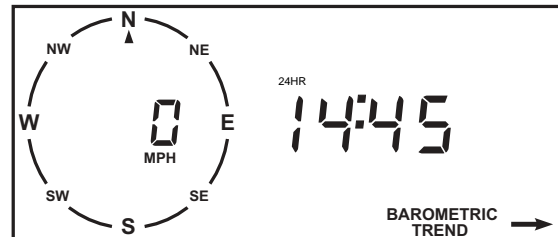

*24-HOUR TIME DISPLAY*

## To Change the Time

1. Press TIME once or twice to select the time.
2. Press UNITS to select the 12-or24-hour format, as desired.
3. Use ENTER to set the correct time (see "Using the Enter Key" on page 16 for instructions).
4. Press any key to exit.

## To Change the Date

1. Press TIME once or twice to select the date.
2. Use ENTER to set the correct date (see "Using the Enter Key" on page 16 for instructions).
3. Press any key to exit.

## To Use the Time Alarm

For instructions on how to use the time alarm, see "Alarms" on page 30.

## TEMPERATURE

The Weather Monitor II measures and displays two temperature readings. One reading is from the temperature sensor inside the console. The other reading is from the external temperature sensor (or optional External Temperature/Humidity Sensor). Both readings may be displayed in either °F or °C in increments of either 1° or 0.1°.

The Weather Monitor II also records high and low temperatures for each set of temperature readings.

### To Display Current Temperatures

1. To display inside temperature, press **TEMP**.  
The inside temperature reading and the word **INSIDE** appear on the display.
2. To display outside temperature, press **TEMP** again.  
The outside temperature reading and the word **OUTSIDE** appear on the display.

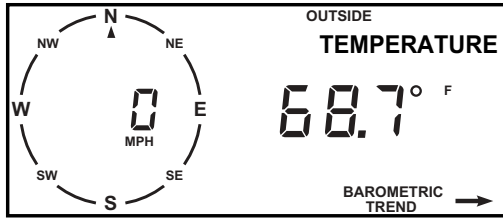

Outside Temperature: 68.7° F

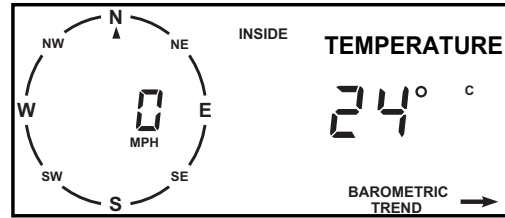

Inside Temperature: 24° C

*INSIDE AND OUTSIDE TEMPERATURE DISPLAYS*

### To Change the Unit of Measure

1. Press **TEMP** once or twice to select inside or outside temperature, as desired.
2. Press **UNITS** until the desired unit of measure and resolution (1° F, 0.1° F, 1° C, 0.1° C) appear in the display.

### To Display High and Low Temperatures

1. Press **TEMP** once or twice to select inside or outside temperature, as desired.
2. Press **UNITS** to select ° F or ° C as desired.
3. Press **RECL** to display the high.  
After a few seconds, the display will show the time the high was recorded, and then the date it was recorded.
4. Press **RECL** again to display the low.  
After a few seconds, the display will show the time the low was recorded, and then the date it was recorded.
5. Press any key to exit.

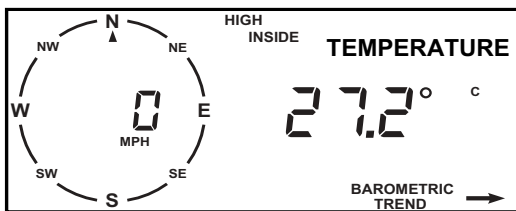

High Inside Temperature: 27.2° C

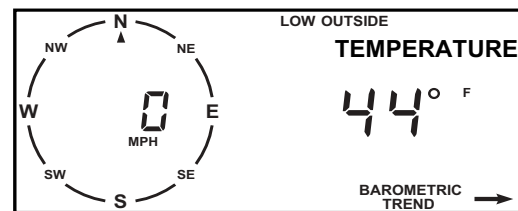

Low Outside Temperature: 44° F

*HIGH AND LOW TEMPERATURE DISPLAYS*

### To Clear High and Low Temperatures

1. Press **TEMP** once or twice to select inside or outside temperature, as desired.
2. Press **RECL** once or twice to select the high or low temperature, as desired.

3. Press CLEAR and hold it down.

The display will flash several times, and then the old reading will be replaced by the current temperature. As the temperature rises and falls, the high and/or low will be updated.

4. Press any key to exit.

---

**Note:** High and low temperatures are independent of each other. Clearing the high temperature does not clear the low temperature, and vice versa. You must clear each individually.

---

## High and Low Temperature Alarms

For instructions on how to use the high and low temperature alarms, see “Alarms” on page 30.

## WIND SPEED AND WIND DIRECTION

The Weather Monitor II shows wind speed and wind direction in two places on the display. They are always shown on the compass rose on the left hand side of the display and can be selected to show on the right hand side.

### About Wind Speed

Wind speed can be displayed in either miles per hour (MPH), kilometers per hour (KPH), nautical miles per hour (KNOTS), or meters per second (M/S). The wind speed readings on the right side of the display and in the compass rose will always be in the same unit of measure.

The Weather Monitor II also records the highest wind speed at your location.

### About Wind Direction

The compass rose is divided into 16 points, each corresponding to a different compass point 22.5° apart. Wind direction is indicated by a flashing arrow at one of these points. The right side of the display expresses wind direction in degree readings.

The right side of the display can be set to display Wind Direction in either high (1° increments) or low (10° increments) resolution. Low resolution is probably the most practical setting since even a relatively steady wind has turbulence and rapidly changing speeds. Low resolution gives you a general indication of wind direction—whether the wind is blowing from a northerly or northeasterly direction, for example.

Under certain circumstances, however, the change in wind direction is as important as the direction itself. Under these circumstances, the Weather Monitor II should be set to display in 1° increments. This change can be significant if, for example, you are trimming the sails of your sailboat

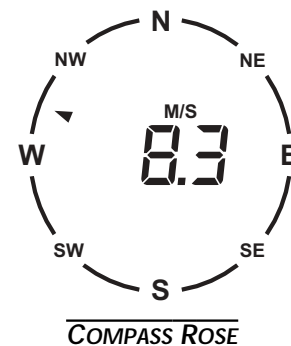

### To Display Current Wind Speed and Wind Direction

1. To display wind speed, press WIND.  
The current wind speed and the word SPEED appear on the display.
2. To display wind direction, press WIND again.  
The current wind direction and the word DIRECTION appear on the display.

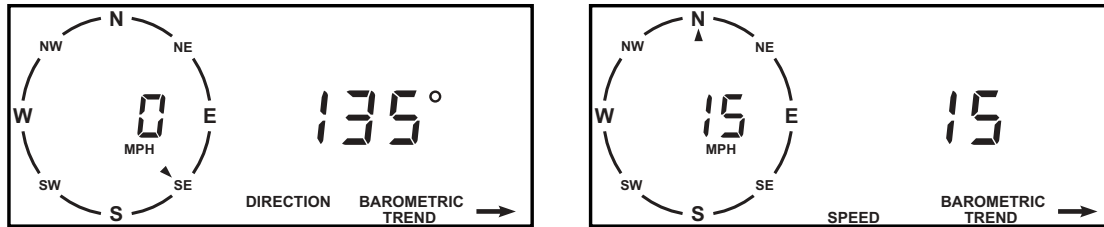

Wind Direction: 135° (SE)

Wind Speed: 15 mph

---

#### WIND DIRECTION AND WIND SPEED DISPLAYS

### To Change the Unit of Measure for Wind Speed

1. Press WIND once or twice as necessary to select wind speed.
2. Press UNITS until the desired unit of measure (MPH, KPH, KNOTS, M/S) appears in the compass rose.

### To Change the Resolution for Wind Direction

1. Press WIND once or twice as necessary to select wind direction.
2. Press UNITS.  
The console switches from high (1°) to low (10°) resolution (or vice versa). To return to the original format, press UNITS again.

---

**Note:** When you change resolution, the word HIGH or LOW appears in the display so you know what resolution you have changed to. Once you have selected a resolution, the word HIGH or LOW disappears from the display.

---

### To Display the High Wind Speed

1. Press WIND once or twice as necessary to select wind speed.
2. Press UNITS to select MPH, KPH, KNOTS, or M/S as desired.
3. Press RECL to display the high.  
After a few seconds, the display will show the time the high was recorded, and then the date it was recorded.
4. Press any key to exit.

### To Clear the High Wind Speed

1. Press WIND once or twice as necessary to select wind speed.
2. Press RECL to display the high.
3. Press CLEAR and hold it down.  
The display will flash several times, and then the high wind speed will be replaced by the current wind speed. As higher wind speeds occur, the high will be updated.

## To Use the High Wind Speed Alarm

For instructions on how to use the high wind speed alarm, see “Alarms” on page 30.

## WIND CHILL

Wind chill is a measure of the effect of wind on our perception of temperature. Through a process known as convection, wind cools off your body by transferring heat more quickly into the surrounding air. As a result, when the wind is blowing, you perceive the temperature to be cooler than it actually is.

The Weather Monitor II automatically calculates wind chill using the wind speed and the outside temperature readings. Wind chill is expressed as a temperature reading, which can be displayed in either °F or °C in increments of 1°. The Weather Monitor II also records the lowest wind chill reading at your location.

## To Display the Current Wind Chill

Press WIND CHILL. The current wind chill and the words WIND CHILL appear on the display.

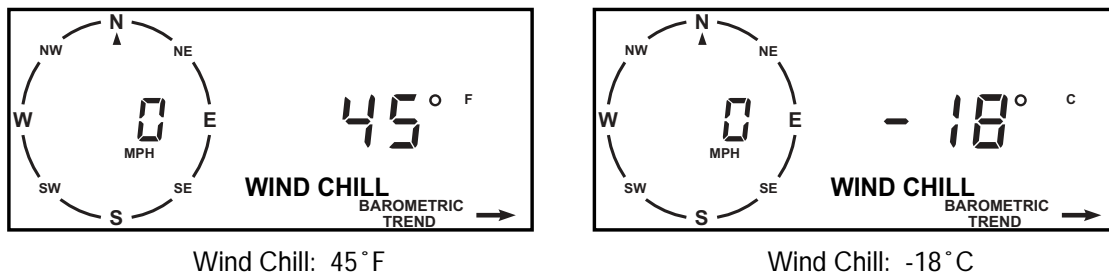

Wind Chill: 45° F

Wind Chill: -18° C

*WIND CHILL DISPLAYS*

## To Change the Unit of Measure

1. Press WIND CHILL.
2. Press UNITS.

The console switches from °F to °C (or vice versa) and the symbol in the display changes from F to C (or vice versa). To return to the original format, press UNITS again.

## To Display the Low Wind Chill

1. Press WIND CHILL.
2. Press UNITS to select °F or °C as desired.
3. Press RECL to display the low.
 

After a few seconds, the display will show the time the low was recorded, and then the date it was recorded.
4. Press any key to exit.

### To Clear the Low Wind Chill

1. Press WIND CHILL.
2. Press RECL.
3. Press CLEAR and hold it down.  
The display will flash several times, and then the low wind chill will be replaced by the current wind chill. As the wind chill falls, the low will be updated.
4. Press any key to exit.

### To Use the Low Wind Chill Alarm

For instructions on how to use the low wind chill alarm, see "Alarms" on page 30.

## RAINFALL

Before you can use the rainfall function on your Weather Monitor II, you must first set up and install the optional Rain Collector. See the booklet included with the Rain Collector for instructions on its use.

## BAROMETRIC PRESSURE

The Weather Monitor II uses a solid state transducer to measure atmospheric pressure. Since atmospheric pressure varies with altitude, the console adjusts this measurement to give the equivalent sea level pressure, referred to as "barometric pressure." The Weather Monitor II can display barometric pressure in inches of mercury (IN), millimeters of mercury (MM), or millibars (MB).

Atmospheric pressure (and barometric pressure) also varies with local weather conditions. Falling pressure is associated with deteriorating weather, while rising pressure is associated with improving weather. Standard or normal barometric pressure is 29.92 inches or 760.0 mm of mercury (Hg) or 1013.2 millibars.

Since atmospheric pressure varies with both altitude and local weather conditions, you must enter the current barometric pressure for your location when you turn on your Weather Monitor II. Once the barometric pressure is set, the Weather Monitor II calculates and displays the correct barometric pressure until the unit is moved to a different altitude.

The Weather Monitor II can also store a barometric pressure reading for comparison. With stored barometric pressure you can determine exactly how much the barometric pressure has risen or fallen over a given period of time. Like the highs and lows for other functions, the stored barometric pressure is accompanied by the time and date it was recorded.

The Weather Monitor II also displays the barometric trend over approximately the past hour. This trend is shown as an arrow in the bottom right hand corner of the display.

## To Set the Barometric Pressure

### 1. Find the current local barometric pressure.

You may be able to get local barometric pressure readings from TV and radio weather reports, or your local airport control tower.

Barometric pressure readings are also available on the internet.

- For barometric pressure readings in the U.S., go to <http://iwin.nws.noaa.gov>. Choose "Text version" and then choose "State Data".
- For barometric pressure readings outside the U.S., a good place to check is [www.wmo.ch](http://www.wmo.ch), click on "Meteorological Information". Choose "WMO Members with Web & Gopher Server".

### 2. Press BAR.

A barometric pressure reading and the symbol IN (or MM or MB) appear on the display.

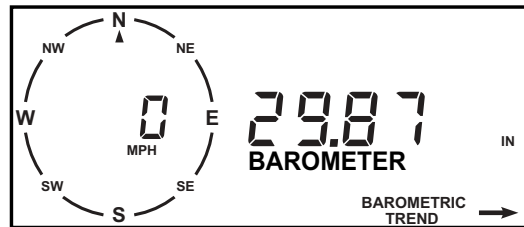

**BAROMETRIC PRESSURE DISPLAY**

### 3. Press UNITS until the desired unit of measure (IN, MM or MB) appears.

### 4. Press ENTER to set the current barometric pressure. (see "Using the Enter Key" on page 16 for instructions).

**Note:** When you enter barometric pressure in millibars, there is a fifth digit—a 1 at the far left. This number changes first when you begin changing barometric pressure. The 1 flashes on and off as you hold ENTER down. Release ENTER when you see the 1 for a barometric pressure of 1000.0 mb or more. Release ENTER when the 1 is not showing for a barometric pressure below 1000.0 mb.

### 5. Press BAR to save the setting.

The number you entered appears as the current barometric pressure.

**Note:** To prevent accidental changing of the barometric pressure once it has been set, hold down the ENTER key for at least eight seconds before the first digit on the left begins to change.

**Barometric Pressure settings drifts over time so, every 4-6 months, check your barometer setting to ensure it is correct.**

## To Display the Current Barometric Pressure

Press BAR. The barometric pressure and the word BAROMETER appear on the display.

### To Change the Unit of Measure

1. Press BAR.
2. Press UNITS until the desired unit of measure (IN, MM or MB) appears in the display.

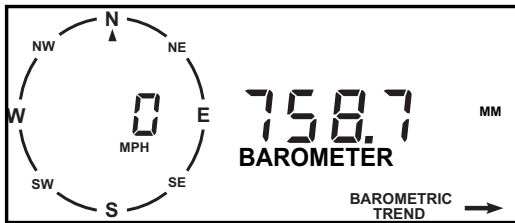

Barometer: 758.7 mm of Hg

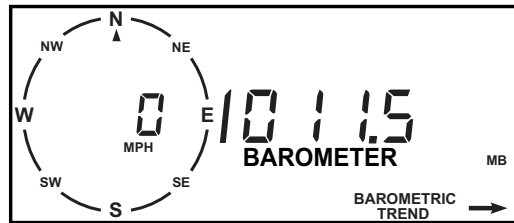

Barometer: 1011.5 mb

#### BAROMETRIC PRESSURE IN MILLIMETERS AND MILLIBARS

### To Display the Stored Barometric Pressure

1. Press BAR to display barometric pressure.
2. Press UNITS to select IN, MM, or MB as desired.
3. Press RECL to display the stored barometric pressure.  
If you have not stored a barometric pressure, the stored barometric pressure will be 0. After a few seconds the display will show the time it was recorded, and then the date it was recorded.
4. Press any key to exit.

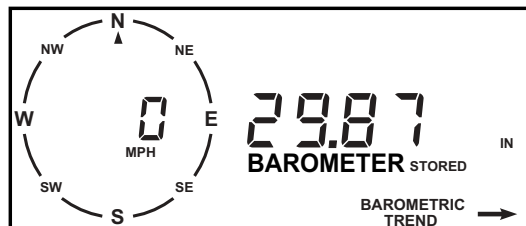

#### STORED BAROMETRIC PRESSURE

### To Store a Barometric Pressure

1. Press BAR.
2. Press RECL to display the stored barometric pressure.
3. Press CLEAR.  
The display flashes several times and then the current barometric pressure appears in the display. The current barometric pressure is now stored, along with the time and date.
4. Press any key to exit.

---

**Note:** Each time you enter a new stored barometric pressure you clear the previous one. There is no way to clear a stored barometric pressure without entering a new one.

---

## The Barometric Trend Function

The barometric trend arrow, which appears on the bottom right hand corner of the display, gives you an indication of which way barometric pressure is moving. If barometric pressure changed by less than 0.02 inches of Hg (1 millibar 0.75 millimeters of Hg) over approximately the past hour, the arrow will be horizontal—steady barometric pressure. If barometric pressure rose by 0.02 inches of Hg or more, the arrow will have an upward slope—rising barometric pressure. If barometric pressure fell by 0.02 inches of Hg or more, the arrow will have a downward slope—falling barometric pressure.



*BAROMETRIC TREND ARROW*

The barometric trend arrow is updated approximately every 15 minutes.

## To Use the Barometric Trend Alarm

For instructions on how to use the barometric trend alarm, see “Alarms” on page 30.

## HUMIDITY

Much of the air surrounding us consists of water vapor. Consequently, water vapor plays an important role in determining weather conditions. When it condenses, the result is dew, fog, rain, snow, frost, and other forms of precipitation. The amount of water vapor in the air also influences how we perceive temperature. Humid days feel hotter because water vapor slows down the natural cooling processes of the human body.

A measurement of the amount of water vapor in the surrounding air is dependent upon temperature since warmer air is capable of holding much more water than cooler air. Thus, relative humidity (usually simply called humidity) is defined as the amount of water vapor presently in the air, divided by the maximum amount of water vapor that the air could hold, given the current temperature. The result is expressed as a percentage.

The Weather Monitor II can measure and display two sets of humidity readings. One reading comes from the sensor located inside the console. The other reading comes from the optional External Temperature/Humidity Sensor. If you do not have this sensor, the Weather Monitor II will not measure outside humidity and all outside humidity display readings will appear as a series of dashes.

The Weather Monitor II also records high and low humidities for each set of humidity readings.

## To Display Current Humidity

1. To display inside humidity, press HUM.

The inside humidity reading and the word INSIDE appear on the display.

2. To display outside humidity, press HUM again.

The outside humidity reading and the word OUTSIDE appear on the display.

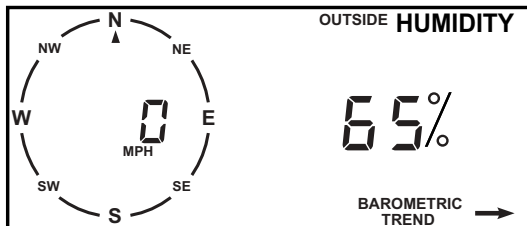

Outside Humidity: 65%

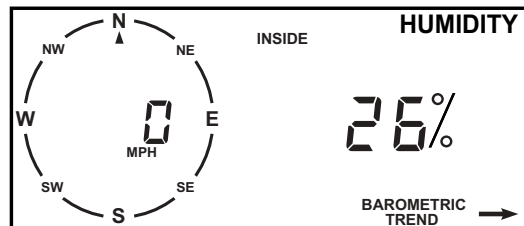

Inside Humidity: 26%

### HUMIDITY DISPLAYS

#### To Display High and Low Humidities

1. Press HUM once or twice to select inside or outside humidity, as desired.
2. Press RECL to display the high.  
After a few seconds, the display will show the time the high was recorded, and then the date it was recorded.
3. Press RECL again to display the low.  
After a few seconds, the display will show the time the low was recorded, and then the date it was recorded.
4. Press any key to exit.

#### To Clear High and Low Humidities

1. Press HUM once or twice to select inside or outside humidity, as desired.
2. Press RECL once or twice to select the high or low humidity, as desired.
3. Press CLEAR and hold it down.  
The display will flash several times, and then the old reading will be replaced by the current humidity. As the humidity rises and falls, the high and/or low will be updated.
4. Press any key to exit.

---

**Note:** High and low humidities are independent of each other. Clearing the high humidity does not clear the low humidity, and vice versa. You must clear each individually.

---

#### To Use the High and Low Humidity Alarms

For instructions on how to use the high and low humidity alarms, see "Alarms" on page 30.

## DEW POINT

Dew point is a measure of the absolute amount of water vapor in the air expressed as a temperature reading. The temperature reading represents the temperature at which water condenses from the air. If temperature and dew point are the same, the result will be fog and/or dew. Dew point can be displayed in either °F or °C, in increments of 1°.

The Weather Monitor II also records high and low dew points, and has a special dew point alarm to alert you when temperature comes within 2°F (1°C) of dew point.

Because dew point is dependent on water vapor (humidity), if you do not have the External Temperature/Humidity Sensor, all dew point displays will appear with a series of dashes in place of a dew point reading.

See the booklet included with the External Temperature/Humidity Sensor for instructions on displaying dew point.

## 6. USING THE CONSOLE FUNCTIONS

### ALARMS

The Weather Monitor II features a set of alarms which can be programmed to sound whenever a reading passes a particular point. Check the chart below to determine which functions have alarms and what kind of alarms they have. All alarms (except barometric pressure, dew point, and time) behave in basically the same way. The general procedure for displaying and setting alarms is covered below.

	<u>HIGH ALARM</u>	<u>LOW ALARM</u>
Time	*	*
Inside Temperature	√	√
Outside Temperature	√	√
Wind Speed	√	X
Wind Direction	X	X
Wind Chill	X	√
Barometric Pressure	**	**
Inside Humidity	√	√
Outside Humidity	√	√
Dew Point	***	***

\* The time alarm is a standard time alarm, just like the one on any alarm clock.

\*\* Because the change in barometric pressure is generally considered more important than the barometric pressure itself, there is a special alarm for barometric trend. The procedure for setting this alarm is covered separately below.

\*\*\* Dew point has a special alarm designed to alert you when the temperature comes within 2° F (1° C) of dew point. Refer to the booklet included with the External Temperature/Humidity Sensor for instructions on using the dew point alarm.

### Alarm Conditions

On all high alarms, the alarm is triggered when a reading reaches the alarm point and will continue to sound until the reading drops below the alarm point. On all low alarms, the alarm is triggered when a reading reaches the alarm point and will continue to sound until the reading rises above that point.

### The Alarm Display

When the alarm sounds, the console makes a high-pitched beeping sound and immediately displays the function triggering the alarm. The word ALARM flashes on and off in the display. The alarm will continue until alarm conditions are no longer met or the alarm is cleared. You can briefly look at other functions by pressing the appropriate key(s), but the display will always return to the alarming function.

If more than one alarm is sounding at once, the Weather Monitor II will scan through all of the triggered alarms, displaying each for approximately four seconds before moving to the next.

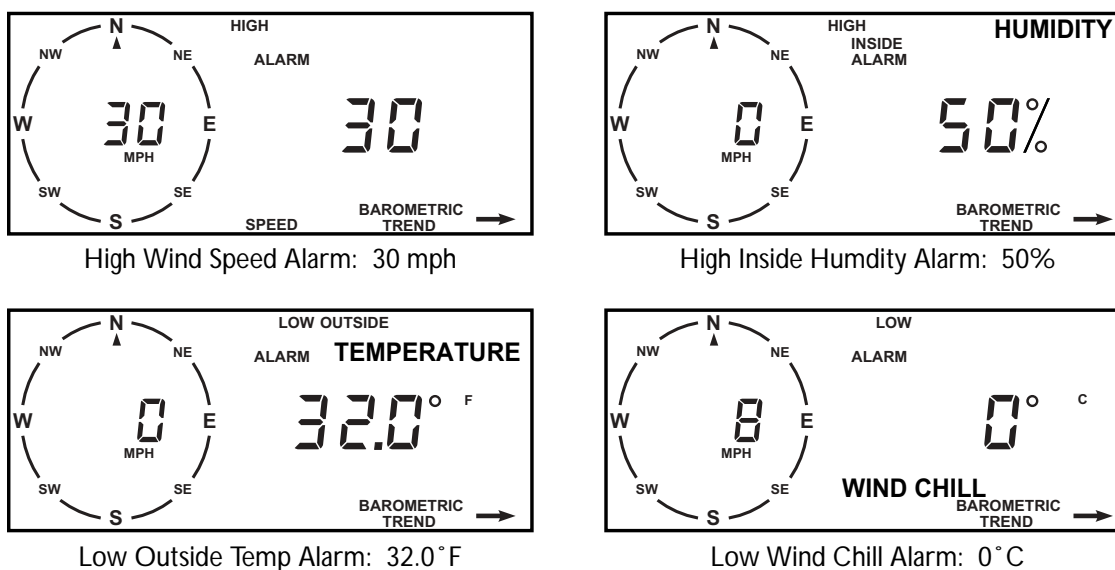

TYPICAL ALARM DISPLAYS

### To Display an Alarm Setting

1. Press the appropriate key to display the function you desire.  
For temperature and humidity you must choose between the inside and outside readings, as each set of alarms is handled separately.
2. Press UNITS to select the desired unit of measure.
3. Press ALARM.  
If you are displaying temperature or humidity, which have two alarm settings each, the high alarm setting appears first.
4. To display the low alarm setting for temperature or humidity, press ALARM again.

### To Set an Alarm

1. Press the appropriate key to display the function you desire.
2. Press UNITS to select the desired unit of measure.
3. Press ALARM until the alarm setting you desire appears on the display.
4. Use ENTER to set the alarm (see "Using the Enter Key" on page 16 for instructions).
5. Press any key to exit.

### Example of Setting an Alarm—Low Outside Temperature Alarm

Suppose you wanted to set the Weather Monitor II alarm to sound when the outside temperature dropped below 40°F.

1. Press TEMP once or twice until outside temperature is displayed.
2. If necessary, press UNITS to change to °F.  
Using the 1°F resolution is probably easiest, though you can set the alarm to 1° or 0.1° resolution for either Fahrenheit or Celsius.

3. Press **ALARM** twice to display the low alarm setting.
4. Use **ENTER** to set the alarm to 40°F (see "Using the Enter Key" on page 16 for instructions).

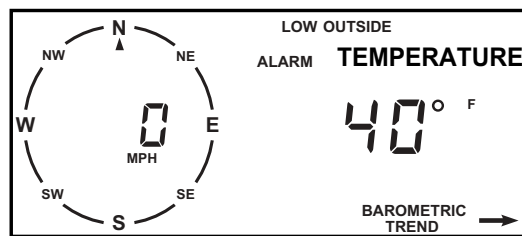

*LOW OUTSIDE TEMPERATURE ALARM (EXAMPLE)*

5. Press **TEMP** to exit.  
The alarm is now set and will sound when the outside temperature drops below 40°F.

### To Set the Barometric Trend Alarm

1. Press **BAR**.
2. Press **UNITS** to select the desired unit of measure.
3. Press **ALARM**.
4. Press **ENTER** and hold it down.

The display will cycle through the possible entries: 0.02, 0.04, and 0.06 inches (0.5, 1.0 and 1.5 mm or 0.7, 1.4 or 2.0 mb). The entry represents a change in barometric pressure over the course of approximately one hour. Therefore, setting the alarm to 0.04 inches means that the alarm will sound if the barometric pressure changes (rises or falls) by 0.04 inches (1 mm or 1.4 mb) in any hour long period. This alarm is checked approximately every 15 minutes.

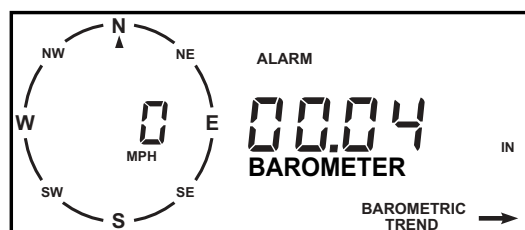

*BAROMETRIC TREND ALARM*

5. Release **ENTER** when the desired setting is on the display.
6. Press any key to exit.

**Note:** *The barometric trend alarm does not discriminate between rising and falling barometric pressure—check the barometric trend arrow to determine if barometric pressure rose or fell.*

### To Silence an Alarm

Press **CLEAR**. The high pitched beeping sound stops, though the alarm is not cleared. The word **ALARM** and the function triggering the alarm remains on the display until alarm conditions are no longer met or the alarm is cleared.

## To Clear an Alarm

1. Since the function triggering the alarm is already on the display, simply press **ALARM** once or twice to get the desired alarm setting (high or low) for that function.  
If more than one alarm is sounding, wait until the function you want to clear appears before you press **ALARM**.
2. Press and hold down **CLEAR** until the display shows a series of dashes.

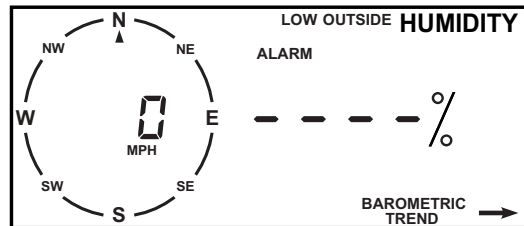

**CLEARING AN ALARM**

3. Press any key to exit.

---

**Note:** Each alarm setting is independent of every other. For instance, clearing the high inside temperature alarm does not clear the low inside temperature, high outside temperature, or low outside temperature alarms. You must clear each alarm individually.

---

## TOTAL CLEAR

The total clear function automatically clears all of the high and low readings as well as the stored barometric pressure at the same time.

The following functions are reset by the total clear function:

- High and Low Inside Temperatures
- High and Low Outside Temperatures
- Stored Barometric Pressure
- High and Low Inside Humidities
- High and Low Outside Humidities
- High and Low Dew Point
- High Wind Speed
- Low Wind Chill

The following functions are not reset by total clear:

- Time
- Date
- Current Barometric Pressure
- Daily and Accumulated Rainfall
- Barometric Trend
- Alarm Settings

### To Use Total Clear

1. Display any function except highs or lows, alarms, or daily accumulated rainfall.
2. Press CLEAR and hold it down.  
The unit will beep and the display will flash seven times and then stop. When this happens, the functions listed above have been cleared.

## AUTO SCAN

The Weather Monitor II can be set to perform an automatic scan of the weather functions. Each reading appears on the display (in the unit of measure you last used) for approximately four seconds before being replaced by the next function in the scan routine. There is a pre-programmed scan routine which reviews weather functions in the order given below.

- Current, High, and Low Inside Temperature
- Current, High, and Low Outside Temperature
- Current and High Wind Speed
- Current Wind Direction
- Current and Low Wind Chill
- Daily and Accumulated Rainfall
- Current and Stored Barometric Pressure
- Current, High, and Low Inside Humidity
- Current, High, and Low Outside Humidity
- Current, High, and Low Dew Point

You may also program a customized scan routine to review only the functions you desire. The console can store one customized scan routine in addition to the pre-programmed scan.

---

**Note:** *You can enter time and/or date into the customized scan routine, though they are not included in the pre-programmed scan routine.*

---

### To Start and Stop a Scan Routine

1. Press SCAN. The pre-programmed scan routine begins.
2. To begin the customized scan routine (if you have entered one), press SCAN again.
3. To stop the scan routine, press any key except SCAN or ENTER.

## To Program a Customized Scan Routine

1. Press SCAN.

2. Press ENTER.

The compass rose and barometric trend arrow disappear and the word SCAN appears. After a few seconds, the display will begin to alternate between the word SCAN and the normal display to let you know you are in scan entry mode.

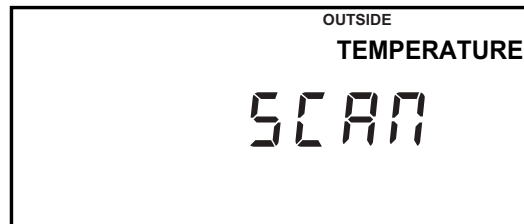

SCAN ENTRY MODE

3. Press the appropriate keys to display the first function you wish to scan.

For example, press HUM twice and RECL once for High Outside Humidity.

4. If desired, press UNITS to change the unit of measure.

5. Press ENTER to store that function in the scan routine.

6. Repeat steps 3,4, and 5 until you have entered all of the functions you wish to scan.

7. When you have entered all the desired functions, press SCAN.

The customized scan routine will begin. Note that the functions you enter will be displayed in the same order they appear during the pre-programmed scan routine, not in the order you entered them.

## To Clear a Customized Scan Routine

Press SCAN, then ENTER, then SCAN again.

## To Change the Customized Scan Routine

To change a scan routine, follow the instructions above (in "To Program a Customized Scan Routine") to enter a whole new customized scan routine. You cannot add or delete a function to an existing scan routine; you must re-enter the scan routine in its entirety.

## To Change the Unit of Measure Within the Scan Routine

Change the unit of measure as described in the individual section for the desired function. Any changes made to the unit of measure outside of the scan routine are reflected inside the scan routine.

## DISPLAY LAMP

The Weather Monitor II contains a lamp so you can read the display in the dark. To turn the lamp on or off, simply press any two keys at once.

**Note:** Leaving the display lamp on for a prolonged period may cause the inside temperature reading to rise by 2-4 °F. This will cause a corresponding drop in the inside humidity reading of 4-6%.

## 7. CALIBRATION NUMBERS

Calibration (CAL) numbers are used to turn raw data from the sensors into meaningful readings on the display. The standard or default CAL numbers are automatically entered by the unit when it is first powered up and whenever power is lost and later restored.

Calibration numbers should not be changed except for certain specialized applications. This section explains why you may wish to change CAL, the equations used by the Weather Monitor II, and the default values for CAL numbers. For instructions on changing CAL, see “Changing Calibration Numbers” on page 37.

---

**Note:** *We do not recommend changing the preset calibration numbers unless you are using a metric rain collector.*

---

### INSIDE AND OUTSIDE TEMPERATURE

Change CAL if you wish to adjust the Weather Monitor II so that it reads the same as another thermometer. Note that there are individual CAL numbers for both inside and outside temperature. If you change CAL for outside temperature, the wind chill reading will also be affected.

$$\text{CALIBRATED TEMPERATURE} = \text{TEMPERATURE} + \text{CAL}$$

Default CAL = 0 (for °F); 0 (for °C).

### WIND SPEED

The four units of measure provided are generally sufficient for most applications. If you change CAL for wind speed, the wind chill readings will be incorrect.

$$\text{CALIBRATED WIND SPEED} = \text{REVOLUTION} \times (1600 / \text{CAL})$$

Default CAL = 1600 (for mph); 995 (for kph); 1843 (for knots); 3578 (for m/s).

### HUMIDITY

Change CAL if your outside humidity reading is off by a consistent amount. A CAL number exists for outside humidity only. If you change CAL, dew point readings will also be affected.

$$\text{CALIBRATED HUMIDITY} = \text{HUMIDITY} + \text{CAL}$$

Default CAL = 0%.

## RAINFALL

Each station uses a rainfall calibration number (CAL) to determine how much water each bucket tip (i.e., pulse) represents. The default calibration number for rainfall assumes that you use a 0.01" rain collector.

$$\text{CALIBRATED RAINFALL} = \# \text{ OF PULSES} \times (1 / \text{CAL})$$

Default CAL = 100 (for 0.01" rain collector).

If you have a 0.2 mm rain collector, you must change the calibration number. *First* adjust the console to display rainfall in millimeters and *then* change CAL to 0005. (For instructions on how to change CAL, see "Changing Calibration Numbers" below). Be aware that the console will revert to its default calibration (i.e., inches) if it loses power.

---

**Note:** Make sure you display rainfall in the appropriate units of measure **before** changing CAL; otherwise you will be setting the wrong calibration number. If, by mistake, you change CAL before switching to the appropriate units, you can rectify the error by switching to the appropriate units and then entering the appropriate CAL (for millimeters, 0005; for inches, 0100).

---

Once the console is calibrated for 0.01" (default) or 0.2 mm, you can switch the display units as often as you like; the console accurately converts rainfall amounts regardless of the type of rain collector you use.

## CHANGING CALIBRATION NUMBERS

1. Press the appropriate key (e.g., TEMP, RAIN, etc.) to display the reading whose CAL number you wish to change.
2. Press UNITS to display the desired unit of measure.
3. If you are changing the CAL for wind speed, temperature, or humidity, press the key you pressed in step 1 (i.e., WIND, TEMP, or HUM) again so the reading you do NOT want to change appears in the display.  
For example, to change outside temperature, display inside temperature. If you are changing the CAL for rain, skip to step 4.
4. Press the key you pressed in step 1 and hold the key down.  
After a few seconds, the display will begin to alternate between the word CAL and the reading you want to change. After a few more seconds, the current calibration number appears.
5. Use ENTER to set CAL. (See "Using the Enter Key" on page 16 for instructions.)  
If you want to enter a negative CAL for temperature or humidity, first enter the number without the negative sign. Then return to the second digit on the left and hold down ENTER. The display cycles through the possible entries, one of which is a negative sign.

---

**Note:** If you do not begin entering numbers within the first second after you select a digit, the display will exit calibration mode and return to its normal display.

---

## RESETTING CALIBRATION NUMBERS TO DEFAULT

1. **Write down the current barometric pressure, accumulated rainfall, and all alarm settings.**  
You will need to reenter these values later.
2. **Also write down all highs, lows, and daily rainfall.**  
These values will be lost and cannot be restored.
3. **Remove the battery, if applicable, and unplug the power adapter from the console.**  
All power must be removed from the unit.
4. **Reattach the power adapter and insert the battery.**  
The unit will start up again and all CAL numbers will be reset to their default values.
5. **Reenter the current barometric pressure, accumulated rainfall, and all alarm settings.**

---

## 8. TROUBLESHOOTING GUIDE

While the Weather Monitor II is designed to provide years of trouble-free operation, occasional problems may arise. If you are having a problem with your unit, please check the following guide before sending the unit in for repair. You will be able to solve many of the problems yourself. If, after checking this guide, you are unable to solve the problem, please call the factory at 1-510-732-7814 for further instructions. Please do *not* return your unit for repair without prior authorization.

### CONSOLE TIPS

#### Display is flashing

- Unit is operating under battery power. Check to be sure the power adapter has not come unplugged from the console or outlet.

#### Display is blank

- Unit is not receiving power. Check to be sure the power adapter has not come unplugged from the console or outlet.
- If power is interrupted, battery may be installed incorrectly. Check and re-install.
- Battery may be run down or old. Replace.

#### Display shows a series of dashes in place of function reading

- Sensor for function which is "dashed out" is not plugged in.
- Cable from sensor for function which is "dashed out" may have broken wire. Check the areas where cables have been secured carefully.
- A reading has exceeded the limits indicated on the specifications table.
- For temperature, wind speed, or rainfall: calibration numbers may be causing readings to exceed display limits. Check calibration number and adjust if necessary.

#### Display is sluggish or console does not work at low temperatures

- The LCD display may not work below 32°F (0°C). Use the external temperature sensor in low-temperature locations and keep the console in a warmer location. See "Displaying the Console" on page 14 for more information.

## Display "locks up"

- Insufficient power during power up or a power surge may cause the console to lock up. If this occurs, remove all power—disconnect any battery backup and the AC/DC power cord. Wait for 1 minute with all of the power removed. Then, while the battery is removed, reconnect the AC power cord and listen for 2 beeps within 10 seconds.

---

**Note:** *If you have the WeatherLink installed, listen for 3 beeps within 20 seconds and then, if all is well, try communicating with the WeatherLink using a computer.*

---

- Once you receive the final beep, install a fresh backup battery, if desired, and put it back into service.
- Davis recommends plugging the console's power adapter into a computer-grade surge protector to help avoid this problem.

## TEMPERATURE TIPS

### Outside temperature seems too high

- Move external temperature sensor out of direct sunlight.
- Check calibration number and adjust if necessary.

### Inside temperature seems too high

- Move the console out of direct sunlight.
- Make sure the console is not in contact with an exterior wall which heats up in sunlight or when outside temperature rises.
- Make sure the console is not near a heater or other internal heat source (lamps, appliances, etc.).
- Check calibration number and adjust if necessary.

### Outside temperature seems too low

- Check calibration number and adjust if necessary.

### Inside temperature seems too low

- Make sure the console is not in contact with an exterior wall which cools down when outside temperature drops.
- Make sure the console is not near an air conditioner.
- Check calibration number and adjust if necessary.

## HUMIDITY TIPS

### Inside humidity seems too high or low

- Make sure the console is not near a humidifier or de-humidifier.
- Check calibration number and adjust if necessary.

## WIND TIPS

### Wind speed reading seems lower than expected

- Check installation by spinning wing cups. If you get a reading, the wind cups are installed correctly. Wind speed reads 0 either all the time or intermittently
- Make sure anemometer cable is plugged into jack marked WIND on junction box.
- Check for broken wire along length of anemometer cable. Carefully check areas where the cable has been secured.
- If you still do not get a reading, the problem is probably with the anemometer. Call factory for return authorization.

### Wind speed reading seems too high or too low

- Check calibration number and adjust if necessary.

### Wind direction reading is dashed out

- Make sure anemometer cable is plugged into jack marked WIND on junction box.
- Check for broken wire along length of anemometer cable. Check the areas where the cable has been secured carefully.
- If these steps do not reveal the problem, the problem is probably with the anemometer. Call the factory for return authorization.

## WIND CHILL TIPS

### Wind chill reading seems too high or too low

- Check calibration number for temperature and wind speed. Adjust if necessary.

## 9. WARRANTY AND REPAIRS

### ONE YEAR LIMITED WARRANTY

For details on Davis' warranty policy, please refer to the *Maintenance, Service, and Repair Information* brochure included with your station.

### QUESTIONS? CALL THE DAVIS SERVICE CENTER

If you have any questions about our products, please call our Service Center at 1-510-732-7814. We'll be glad to help. Most questions can be answered while you're on the phone. Sorry, we're unable to accept collect calls.

### FCC PART 15 CLASS B REGISTRATION WARNING

This equipment has been tested and found to comply with the limits for a Class B digital device, pursuant to Part 15 of the FCC Rules. These limits are designed to provide reasonable protection against harmful interference in a residential installation. This equipment generates, uses, and can radiate radio frequency energy and, if not installed and used in accordance with the instructions, may cause harmful interference to radio communications.

However, there is no guarantee that interference will not occur in a particular installation. If this equipment does cause harmful interference to radio or television reception, which can be determined by turning the equipment on and off, the user is encouraged to try to correct the interference by one or more of the following measures:

- Reorient or relocate the receiving antenna.
- Increase the separation between the equipment and receiver.
- Connect the equipment into an outlet on a circuit different from that to which the receiver is connected.
- Consult the dealer or an experienced radio/TV technician for help.

Changes or modifications not expressly approved in writing by Davis Instruments may void the user's authority to operate this equipment.

---

## SPECIFICATIONS

### Inside Temperature

Range: -5° to 140° F (-20° to 60° C)  
Accuracy: ± 1°F (± 0.5°C)

### Outside Temperature

Range: -50° to 140° F (-45° to 60° C)  
Accuracy: ± 1°F (± 0.5°C)

### Wind Direction

Display Resolution: 16 points (22.5°) on compass rose, 1° in digital display  
Accuracy: ± 7°

### Wind Speed

#### Large Wind Cups

Range: 2 to 150 mph, 3 to 241 km/h, 2 to 130 knots, 1 to 67 m/s  
Accuracy: ± 2 mph, 3 km/h, 2 knots, 1 m/s or ±5%, whichever is greater

#### Small Wind Cups

Range: 3 to 175 mph, 5 to 282 km/h, 3 to 150 knots, 1 to 67 m/s  
Accuracy: ± 2 mph, 3 km/h, 2 knots, 1 m/s or ±5%, whichever is greater

### Wind Chill

Range: -134° to 98°F (-92° to 37°C)  
Accuracy: ± 2°F (± 1°C)

### Rainfall

Daily Range: 0 to 40.95" (0 to 819 mm)  
Accumulated Range: 0 to 99.99" (0 to 9999 mm)  
Accuracy: ±(4% + 1 count) for rates from 0.01" to 2" (0.2 mm to 50 mm) per hr;  
±(5% + 1 count) for rates from 2" to 4" (50 mm to 100 mm) per hr

### Barometric Pressure

Range: 26.00 to 32.00"; 660.0 to 810.0 mm; 880.0 to 1080.0 hPa  
Accuracy: ± 0.05"; ± 1.3 mm; ± 1.7 hPa

### Inside Humidity

Range: 10 to 90% RH  
Accuracy: ± 3%

### Outside Humidity

Range: 0 to 100% RH  
Accuracy: ± 3% (1 to 90% RH), ± 4% (90 to 100% RH)

### Time

Accuracy: ± 15 sec/month



3465 Diablo Avenue, Hayward, CA 94545-2778  
510-732-9229 • Fax: 510-732-9188  
E-mail: [info@davisnet.com](mailto:info@davisnet.com) • [www.davisnet.com](http://www.davisnet.com)